

Activity Chair

Rifton Activity Chair

R820, R830, R840, R850, R860 & R870

Product Manual



Hi/lo Base



Standard Base



Contents

Important information	4
Safety messages	5
Recommended use	6
User and item dimensions	6-8
Check your order	9
Basic components	
Backrest and pads	9
Seatbelt	10
Arm supports	11-12
Seat depth	13
Tilt-in-space	13
Spring options	14-16
Seat quick-connect	17-18
Standard base	
Adjustable legs	19
Seat height	19
Footboard	19
Hi/lo base	
Seat height	20
Caster brakes and swivel lock	21
Footboard	22

Contents continued

Components

Headrests	23
Whitmyer adapter	24
Lateral supports	25
Chest strap	26
Butterfly harnesses	27
Thigh belt	28
Pelvic harness	29
Hip guides	30
Abductor	31
Adductors	31
Leg prompts and ankle straps	32
Sandals and wedges	33
Lumbar and seat support kit	34
Backrest filler pad	34
Tray	35
Handhold	35
Push handles	36
Mini kit	37
Maintenance, cleaning and warranty	38
Materials and user modifications	39

IMPORTANT

Please save this product manual for future reference. Additional copies are available at <http://www.rifton.com/customer-service/product-manuals>.

Key for users

Use this key to determine which sections of this product manual apply to you.

 **Technical Users** For professionals who order and set up Rifton products.

 **Home Users** For care-givers who use Rifton products on a regular basis.

 **Maintenance Personnel** For anyone who is responsible for service or re-ordering of Rifton products and parts.

WARNING



- Thoroughly read and understand the information in this product manual before attempting to use this product. If the procedures and instructions in this product manual are not followed, serious injury or death could occur.
- A qualified professional must assess the appropriateness and safety of all equipment for each user.
- This product is intended for use by clients of unreliable judgment. Adult supervision is required at all times.
- To prevent falls and injuries:
 - Do not use this product on rough and uneven terrain, around swimming pools, or near stairways.
 - Ensure the appropriate use of straps and supports at all times. Straps and supports are provided for the safety of the user and must be carefully adjusted for comfort and security.
 - Tighten all adjustment knobs before use and immediately after making any adjustments.
- To prevent pinching or crushing:
 - Keep clients away from under the seat of the chair.
 - Keep hands above the seat when the spring option is in use.
- To prevent falls, strangulation, head entrapment or other injuries, always use seatbelt or pelvic harness when the tray, chest straps, thigh belt, mini trunk support, or butterfly harness are in use.
- Do not use this product for clients outside the height and weight limits specified in this manual.
- Do not use this product as a transport chair in vehicles.
- To prevent structural failure, which may result in serious injury or death:
 - Inspect this product and components regularly for loose or missing screws, metal fatigue, cracks, broken welds, missing attachments, general instability or other signs of excessive wear.
 - Immediately remove this product from use when any condition develops that might make operation unsafe.
 - Do not use Rifton components or products for any purpose other than their intended use.

Recommended use

The Rifton Activity Chair is a Class 1 medical device. It is intended to provide comfortable seating with adjustable support for people with disabilities in the classroom or at home. The chair allows for growth, can be used by multiple users and is available with various components that are easily removable as the client gains independence.

Small user and item dimensions

User dimensions – inches (cm)	R820 Standard base	R830 Hi/lo base
Height	32–48 (81-122)	32–48 (81-122)
with mini kit	28–38 (71-97)	28–38 (71-97)
 <p>Key user dimension: height The user's overall height is a general guide to help you select the appropriate chair. Choose the model that allows for growth.</p> <p>Important: Make sure that seat width, depth and height are adequate for each individual user, and that the user's weight does not exceed the maximum weight recommended.</p>		
Item dimensions – inches (cm)	R820 small Standard base	R830 small Hi/lo base
Frame width	short legs: 21 (53)	26 (66)
	long legs: 23 (58)	
	short legs w/ casters: 22½ (57)	
	long legs w/ casters: 23½ (60)	
Seat height above floor	short legs: 9½–12½ (24-32)	10–25 (25-64)
	long legs: 18½–21½ (47-55)	
	short legs w/ casters: 13½–16½ (34-42)	
	long legs w/ casters: 18½–21½ (47-55)	
Seat angle (tilt-in-space) – degrees	15° forward, 15° back	15° forward, 25° back
Backrest angle – degrees	5° forward, 20° back	5° forward, 20° back
Footboard knee angle – degrees	45°–110°	45°–110°
Seat height above footboard	7–12 (18–30)	7–12 (18–30)
Seat width with hip guides (without hip guides)	7–9 (18–23)	7–9 (18–23)
	12 (30)	12 (30)
Seat depth	8–12 (20-30)	8–12 (20–30)
with mini kit	7–11 (18-28)	7–11 (18–28)
Armrest height above seat	5–7½ (13-19)	5–7½ (13–19)
Trunk support width	5½–11½ (14-29)	5½–11½ (14–29)
Backrest height	12½–15½ (32-39)	12½–15½
Headrest height above seat	14½–21 (37–53)	14½–21 (37–53)
Max. working load – lbs. (kg)	75 (34)	75 (34)

Medium user and item dimensions

User dimensions – inches (cm)	R840 Standard base	R850 Hi/lo base
Height	40–56 (102–142)	40–56 (102–142)
 <p>Key user dimension: height The user's overall height is a general guide to help you select the appropriate chair. Choose the model that allows for growth.</p> <p>Important: Make sure that seat width, depth and height are adequate for each individual user, and that the user's weight does not exceed the maximum weight recommended.</p>		
	Item dimensions – inches (cm)	R840 medium Standard base
Frame width	short legs: 23¼ (59) long legs: 24½ (62) short legs w/ casters: 24½ (62) long legs w/ casters: 25½ (65)	27½ (70)
Seat height above floor	short legs: 12½–16½ (32–42) long legs: 19–23 (48–58) short legs w/ casters: 16–20 (41–51) long legs w/ casters: 19–23 (48–58)	12–23 (30–58)
Seat angle (tilt-in-space) – degrees	15° forward, 15° back	15° forward, 25° back
Backrest angle – degrees	5° forward, 20° back	5° forward, 20° back
Footboard knee angle – degrees	45°–110°	45°–110°
Seat height above footboard	7¾–15¼ (19.5–38.5)	7¾–15¼ (19.5–38.5)
Seat width with hip guides	8½–11½ (22–29)	8½–11½ (22–29)
without hip guides	14 (36)	14 (36)
Seat depth	11–16 (28–41)	11–16 (28–41)
Armrest height above seat	7–10½ (18–27)	7–10½ (18–27)
Distance between laterals	6½–12 (17–30)	6½–12 (17–30)
Backrest height	15½–19 (39–48)	15½–19 (39–48)
Headrest height above seat	17½–24½ (44–62)	17½–24½ (44–62)
Max. working load – lbs. (kg)	150 (68)	150 (68)

Large user and item dimensions

User dimensions – inches (cm)	R860 Standard base	R870 Hi/lo base
Height	50–74 (127–188)	50–74 (127–188)
 <p>Key user dimension: height The user's overall height is a general guide to help you select the appropriate chair. Choose the model that allows for growth.</p> <p>Important: Make sure that seat width, depth and height are adequate for each individual user, and that the user's weight does not exceed the maximum weight recommended.</p>		
	Item dimensions – inches (cm)	R860 large Standard base
Frame width	short legs: 26¾ (68)	29¾ (75)
	long legs: 26¾ (68)	
	short legs w/ casters: 27¾ (71)	
	long legs w/ casters: 27¾ (71)	
Seat height above floor	short legs: 16½–20½ (42–52)	16–24 (41–61)
	long legs: 20–24 (51–61)	
	short legs w/casters: 16½–20½ (42–52)	
	long legs w/ casters: 20–24 (51–61)	
Seat angle (tilt-in-space) – degrees	15° forward, 15° back	15° forward, 25° back
Backrest angle – degrees	5° forward, 20° back	5° forward, 20° back
Footboard knee angle – degrees	45°– 110°	45°– 110°
Seat height above footboard	11¼–21¼ (28.5–54)	11¼–21¼ (28.5–54)
Seat width with hip guides	11–14 (28–36)	11–14 (28–36)
	without hip guides	17 (43)
Seat depth	15–20 (38–51)	15–20 (38–51)
Armrest height above seat	7–10½ (18–27)	7–10½ (18–27)
Distance between laterals	9½–14 (24–36)	9½–14 (24–36)
Backrest height	19–24 (48–61)	19–24 (48–61)
Headrest height above seat	19½–29½ (50–75)	19½–29½ (50–75)
Max. working load – lbs. (kg)	250 (113)	250 (113)

Check your order

Your Rifton chair has been shipped according to your specifications. It will require some tool-free assembly. Follow these instructions to insure that your chair is put together and used correctly. This product manual is comprehensive and may discuss features not included in your chair.

If your shipment is incomplete or in any way damaged on arrival, please call Customer Service, 800.571.8198.

Basic item

A Quick Reference Guide for your chair is located behind the backrest pad.

Tip: Every white lever or button indicates a point of adjustment.

Backrest

Backrest angle and height adjust with one-hand levers.

Figure 9a: To adjust the backrest angle, squeeze white backrest angle lever (A) and move the backrest forward or backward to the desired angle, then release the lever.

To adjust backrest height, press the backrest height lever (B) and raise or lower the backrest to desired position. Release the lever and click the backrest into position.

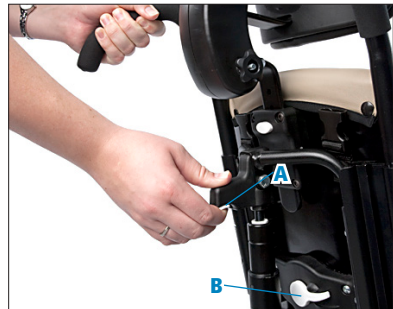

Figure 9a

Pads

Backrest and seat pads snap into position.

Figures 9b and 9c: The backrest pad has a Rifton tag and is snapped onto studs (C) located behind top and bottom edge of backrest.

The seat pad has no tag and is snapped onto studs (D) located under front and back edge of seat.



Figure 9b

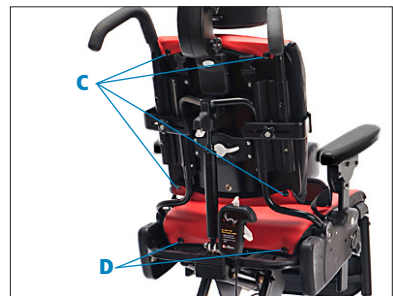

Figure 9c

Seatbelt

⚠ WARNING To prevent falls, strangulation, head entrapment or other injuries, always use seatbelt or pelvic harness when the tray, chest straps, thigh belt, mini trunk support or butterfly harness are in use.

Figure 10a: To attach the seatbelt, make sure the metal clip (A) is positioned so the strap is angled forward. Press the clip firmly into the slot (B) until you hear a click, and check that the clip locks and holds when pulled. Repeat on the other side of the seat.

To remove the seatbelt, use a pen to press small white button (C) just below clip slot on side of seat, and pull belt up to disengage clip. Repeat on the other side of the seat.

Tip: The seatbelt can be clipped into either set of small slots (B) at the sides of the chair.



Figure 10a

Arm supports

A pair of either armrests or forearm prompts were purchased with the chair.

Insert arm supports into large slots at either side of seat.

Both types of arm supports can be removed for side transfers.

Figure 11a: To insert the arm support and adjust its height, press the white button (A) just below the arm support slot at the side of the seat. Insert arm support, move it up or down to required height, release button and make sure it audibly locks into place.

To remove the arm support, press the white button (A) below the arm support slot and pull the arm support up.

Armrests can be set at a wide range of angles.

Tip: Cut-outs on armrests should be toward back of chair.



Figure 11a (Armrests)

Figure 11a: To set the angle of the armrest, lift the white tab (B) below the outer edge of the armrest and rotate the armrest to the desired angle. Release the tab and make sure the armrest audibly locks into place.

Arm supports continued. . .

Forearm prompts adjust fully to facilitate trunk and head control while sitting.

Figure 12a: Forearm prompts are attached using a clamp and post system. The clamp attaches with a knob (A) to any position on the bar, and can be attached on the inside or outside of the bar (B).

Figure 12b: The post (C) fits into the clamp and provides up/down and rotational adjustment. The arm prompt can be attached to the post at several angles by sliding or rotating to achieve the best position for a user's comfort and function. Loosen the knob (D) to make adjustments. Slide or rotate the handgrip by loosening, then tightening knob (E).

Figure 12a: Adjust the straps (F and G) and secure them with the hook and loop fasteners (hooks facing away from the user's arm).



Figure 12a (Forearm prompts)

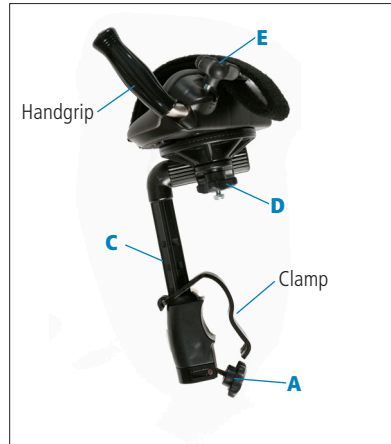

Figure 12b

Seat depth

Figure 13a: To adjust the seat depth, pull the white handle (A) located below the seat. Move the seat forward or back to the desired position and release handle. Make sure the seat audibly locks into place.



Figure 13a

Tilt-in-space

⚠ WARNING To prevent pinching or crushing, keep hands and limbs away from moving parts when adjusting chair.

Tilt-in-space allows the entire seat and backrest to be adjusted to any angle in the range of -15° to $+15^{\circ}$. (Angle is affected by dynamic spring, see following pages.) This enables the user to sit in an active or a relaxed position.

Figure 13b: To adjust the tilt-in-space angle, place one hand on push handle or top of backrest and use the other hand to squeeze the tilt lever (B) and safety lock (C). Push forward or pull backward on push handle or backrest until the desired angle is reached, then release the levers to lock the seat and backrest into the desired position.



Figure 13b

Figure 13c: Use the angle indicator on the side of the chair for consistent positioning.



Figure 13c

Dynamic backrest and seat

The dynamic spring option is designed for user-initiated movement allowing the chair to “bounce.” The spring feature can be locked to provide two ranges of adjustment: forward leaning or active mode, and reclined or relaxed mode.

Figures 14a and 14b: The dynamic backrest is an option on all chairs. It is controlled by the cylinder behind the backrest.

Figures 14a and 14c: The dynamic seat is an option on standard bases only. It is controlled by the cylinder under the seat.

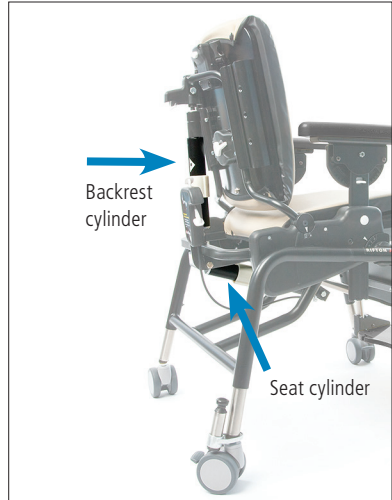

Figure 14a



Figure 14b Dynamic backrest



Figure 14c Dynamic seat

Dynamic backrest

Figure 15a: The dynamic backrest (if installed) is controlled by the dynamic cylinder behind the backrest.

The dynamic backrest has three functions **Figures 15b and 15c:**

- 1. Dynamic spring unlocked.** Turn the white twist-lock collar clockwise to give 10° dynamic movement. Using the backrest angle adjustment lever adjust the dynamic range between -20° and +5°.
- 2. Spring locked–forward adjustment.** With the backrest tilted forward, turn the white twist-lock collar counterclockwise. Using the angle adjustment lever adjust the backrest angle between -10° and +5°.
- 3. Spring locked–reclining adjustment.** While the spring is unlocked, push the backrest into a reclining position. This is easier to do with the client in the chair. Turn the white twist-lock collar counterclockwise. Using the angle adjustment lever adjust the backrest angle between -20° and -5°.

Tip: When locking the spring, move the backrest forward or back to enable the twist-lock collar to slip easily into position.



Figure 15a

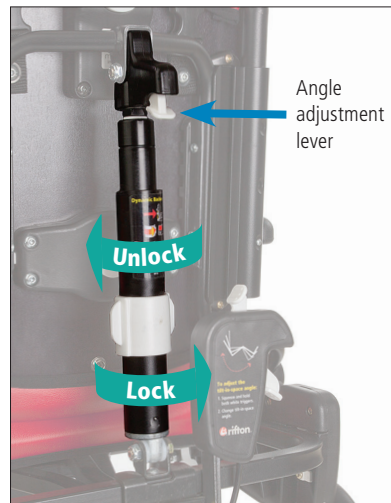

Figure 15b

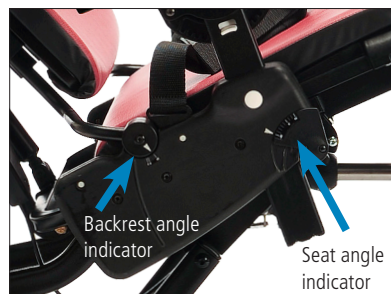

Figure 15c

Dynamic seat (standard base only)

Figure 16a: The dynamic seat (if installed) is controlled by the dynamic cylinder underneath the seat.

Figures 16b and 16c: The dynamic seat has three functions:

- 1. Dynamic spring unlocked.** Turn the twist-lock collar clockwise to allow 10° of dynamic movement. Using the tilt-in-space adjustment lever adjust the dynamic range between -15° and +15°.
- 2. Spring locked—forward adjustment.** With the chair tilted forward, turn the white twist-lock collar under the seat counterclockwise. Using the tilt-in-space adjustment lever adjust the angle of the seat between -5° and +15°.
- 3. Spring locked—reclining adjustment.** While the spring is unlocked, tilt the seat into a fully reclined position. This is easier to do with the client in the chair. Turn the white twist-lock collar counterclockwise. Using the tilt-in-space adjustment lever adjust the tilt between -15° and +5°.

Tip: When locking the spring, move the backrest forward or back to enable the twist-lock collar to slip easily into position.

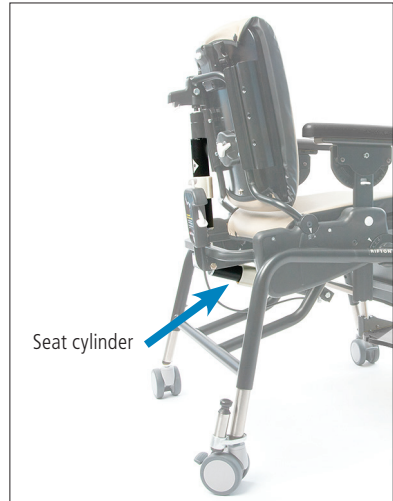

Figure 16a



Figure 16b

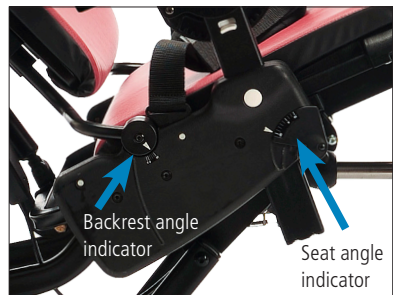

Figure 16c

Seat quick-connect

The Rifton Activity Chair seat and backrest unit can be detached from its base and re-attached to any other Rifton Activity Chair base of the same size. Thus, a Rifton Activity Chair standard base can be converted to a hi/lo base and vice versa, by ordering the base required.

Detaching seat and backrest:

Figure 17a: If your chair has a footboard, first disconnect the angle adjuster. To do this, reach behind the seat and remove the pin holding the gas spring in place, so that it hangs freely. Lock casters if present, and remove the arm supports.

Figure 17b: Find two white levers (A and B) located beneath the chair seat. Place one hand under front edge of the seat and lift it up. At the same time, with the other hand, pull lever (A) towards the front of the chair. Still lifting the front edge of seat, pull the second lever (B) towards the front of the chair to disengage the seat from the crossbar (C).

Figure 17c: Once the front of the seat is disengaged, pull the entire seat and backrest towards the front of the chair until the seat hoop (D) disengages from the metal prongs (E).



Figure 17a

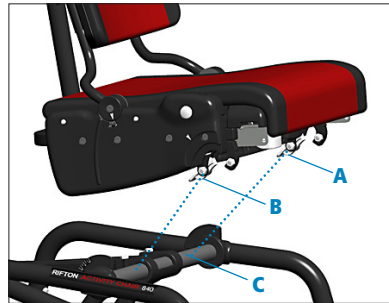

Figure 17b

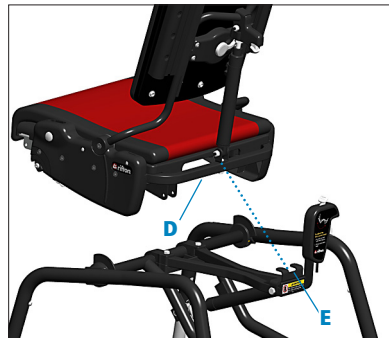

Figure 17c

Attaching seat and backrest

⚠ WARNING To prevent falls and injury, ensure that the seat is firmly attached at the front and back before use.

If the seat is being installed on a hi/lo base, raise the base to its full height first.

Figure 18a: To attach, slide the seat hoop (D) under the prongs (E) on base, centering the backrest column between the prongs.

Figure 18b: Then lower the seat onto the crossbar (C), pushing it firmly down on front edge until it snaps into place.

Figure 18c: Reconnect the footboard gas spring to its bracket behind the seat by lining up the holes and inserting the pin (F). Make sure the pin goes all the way through and the footboard is secure before use.

Tip: Detaching the seat from the base and re-attaching it to another base works best with two people, one on either side of chair.

Tip: The front wheels of the R850 and R870 will be off the ground when the seat is not installed. Set the rear wheel brakes to stabilize the chair, install the seat. The front wheels will go down.

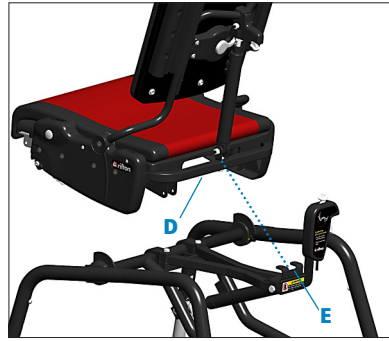

Figure 18a

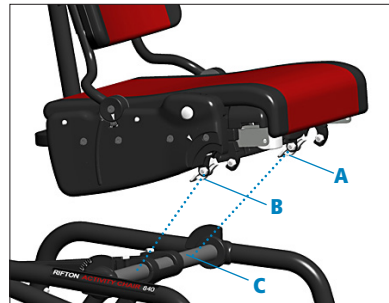

Figure 18b



Figure 18c

Standard base

Adjustable legs

⚠ WARNING To prevent falls and injury:

- Adjust all legs on a chair to the same length.
- Always use four legs of a set together on one chair; do not connect legs of varying lengths or varying features to the same chair.

⚠ CAUTION To permit steering and prevent injury, ensure that the caster with the swivel lock function is inserted into the right rear leg of the base frame (see Figure 19b).

For more information on caster function, see page 21.

A set of four long or short legs, or four long or short legs with casters, have already been purchased with the standard base. Additional sets of legs may be purchased as an accessory.

Figure 19a: To connect a leg to the chair, press the snap button and insert the leg into the housing. Release the snap button and make sure the leg clicks into place. To disconnect a leg from the chair, press the snap button and pull the leg out of housing.

Seat height

Figure 19a: The selection of long or short legs, with or without casters will impact seat height. To adjust seat height, press snap button on each adjustable leg, push or pull leg to desired setting, release snap button and make sure it audibly locks into place.

Footboard

The footboard is an accessory for the standard base. For information on the footboard and its adjustments, see p. 22.

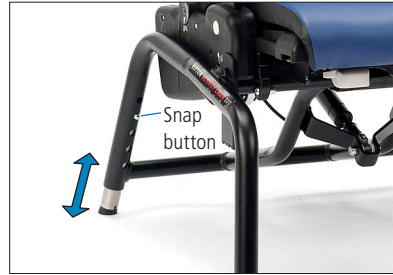

Figure 19a



Figure 19b

Hi/lo base

⚠️ WARNING To prevent pinching or crushing, keep hands and limbs away from moving parts when adjusting chair.

Large & medium chair seat height (R850 & R870)

Figure 20a: To adjust the seat height, use the foot pedal located at the rear of the chair. To raise the seat, repeatedly pump the foot pedal until the desired height is achieved. To lower the seat, lift the foot pedal up until the seat descends to the desired height.

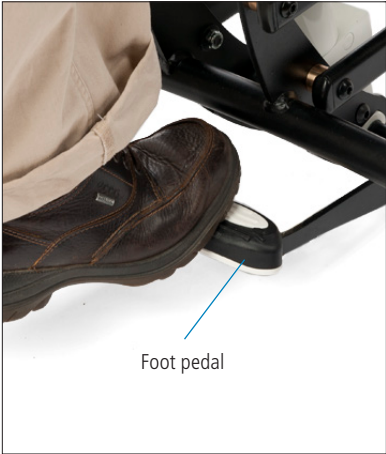

Figure 20a

Small chair seat height (R830)

Figure 20b: To adjust the seat height, use the handle behind backrest. Squeeze and hold both triggers while pulling up or pushing down.

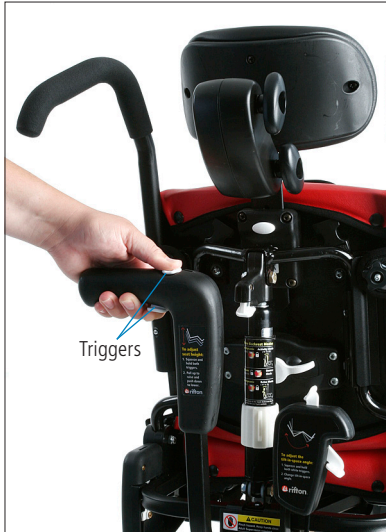

Figure 20b

Caster brakes

⚠ WARNING To prevent falls and injury, apply caster brakes prior to transferring clients into or out of the chair.

Figure 21a: To apply the brake, step down on the pedal (A). To release the brake, lift the pedal up.

Swivel lock (R830)

The swivel lock can be used to keep the chair from drifting sideways when it is being pushed.

Figure 21b: To apply the swivel lock, position the caster directly beneath the swivel lock post and push the handle down with your foot. The swivel lock post will drop into the caster groove and stop just above the brake pedal.

To release the swivel lock, pull up on the white knob until the snap button audibly locks into place above the metal collar.

Directional Assist Wheel (R850, R870).

Figure 21c: The Directional Assist wheel makes navigation smoother and ensures seamless forward movement.

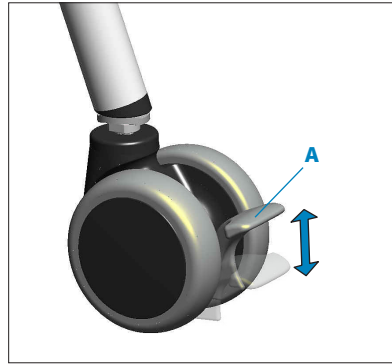

Figure 21a

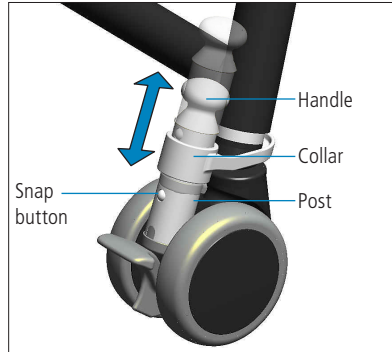

Figure 21b



Figure 21c

Footboard

⚠️ WARNING

To prevent falls and injury, ensure footboard push buttons have engaged on both sides before allowing client to step onto footboard.

⚠️ CAUTION

To prevent pinching or crushing, keep hands away from pinch points on the footboard.

Figure 22a: The footboard supports the user's feet when the seat is too high for the feet to touch the floor. It also serves as a base for ankle straps, sandals and wedges. The footboard supports the weight of the user during transfers, or it can flip up or be swung out of the way beneath the seat.

Figure 22b: To set the knee angle of footboard, reach beneath seat and push or pull the white lever (A) on the gas spring. With the other hand, move the footboard to the desired setting, then release the lever and make sure the footboard locks into place.

Figure 22c: To adjust the footboard height, simultaneously press the white footboard buttons (B) located on both sides of the footboard. Slide the footboard up or down to the desired setting. Make sure the footboard audibly locks into place on both sides.

Figure 22d: To adjust the footplate angle, press the white button (C) in the center of the heel bar, and move the footplate.

Inset photo: The adjustment is easier if the flip up feature is locked with the latch at the rear of the footplate.



Figure 22a



Figure 22b

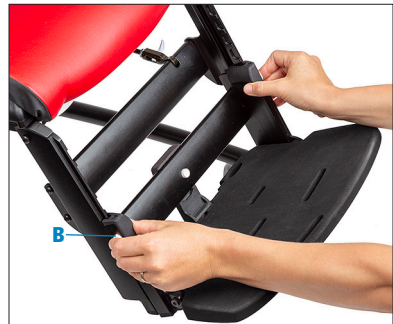

Figure 22c



Figure 22d

Components

Headrests

Figure 23a: Headrests with a flat, contoured or adjustable winged headpiece can be purchased.



Figure 23a

The adjustable winged headpiece allows each wing to adjust independently from almost flat to perpendicular, providing more depth and width possibilities.

Figure 23b: To attach and adjust the headrest height, press the white button (A), insert the metal headrest bar and raise or lower it to the desired setting. Release the button and make sure the headrest audibly locks into place.



Figure 23b

To adjust the depth and angle of the headrest, loosen both black knobs. Move the headrest to the desired position and tighten both knobs securely.

Whitmyer adaptor



WARNING This product must always be assembled and serviced by a responsible adult.

Figure 24c: Whitmyer headrests can be installed on all Rifton Activity Chairs. Rifton’s adapter gives you the option to use a Whitmyer M2100-WB headrest mounting bracket and Whitmyer Onyx Headrest Support System.

Assembly

1. **Figure 24a:** To adapt to the Whitmyer Onyx Headrest Support System, purchase the Whitmyer M2100-WB mounting bracket from an authorized Whitmyer dealer.
2. Using a screwdriver and the T20 power tip provided, remove the four screws holding the Rifton headrest bracket. Remove bracket from backrest.
3. **Figure 24b:** Use the same 4 screws to attach the adapter (A) to the backrest. Do not over-tighten the screws.

Figure 24a: Securely fasten the Whitmyer M2100-WB mounting bracket to the adapter using the two ¼" cap screws that come with the Whitmyer mounting bracket. These bolts require a 3/16" allen wrench.

NOTICE

The customer assumes full responsibility that this field modification is correctly and safely completed. Rifton does not recommend nor guarantee that the Whitmyer headrest will satisfy the needs of the customer. Rifton is not responsible for the installation or safe use of Whitmyer products.



Figure 24a



Figure 24b



Figure 24c

Lateral supports

Lateral supports provide comfortable lateral support for the user and are fully adjustable in height, width and angle. They can be purchased either with or without chest strap attached.

Figures 25a and 25b: To attach and/or adjust lateral support (A), loosen black knob (B) and insert the key (C) into extrusion (D) behind backrest. Adjust height, angle and width of laterals to fit client by sliding lateral support up and down the extrusion sliding bracket (E), and by rotating the bracket around the knob. When desired adjustment is reached, tighten knobs firmly.



Figure 25a (Chair top view)

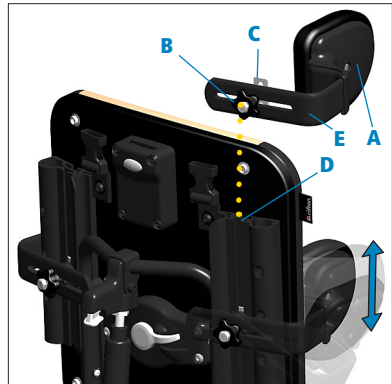

Figure 25b

Chest strap

⚠ WARNING To prevent falls, strangulation, head entrapment or other injuries:

- Always use seatbelt or pelvic harness when the tray, chest straps, thigh belt, mini trunk support or butterfly harness are in use.
- Ensure correct adjustment and positioning of the chest strap at each use.

The chest strap provides anterior support. Two types of chest straps can be purchased: one for use with lateral supports, the other for use on its own.

The stand-alone chest strap may be used with lateral supports, but will not be in line with lateral supports like the compatible chest strap is.

Figure 26a: To attach the chest strap to the lateral supports, thread the loop at either end of the chest strap over the knob and key assembly of lateral supports, making sure buckle faces away from the client.

Loops can be threaded either with the chest strap encompassing the lateral supports, or with the straps on the inside of the lateral supports.

Figures 26b and 26c: The stand-alone chest strap is wider than the chest strap for use with the lateral supports. To attach it, loosen the black knobs at both ends of the strap and insert the keys into the extrusions behind the backrest. Slide the knobs up and down until the desired height is achieved, then tighten the knobs firmly.



Figure 26a



Figure 26b

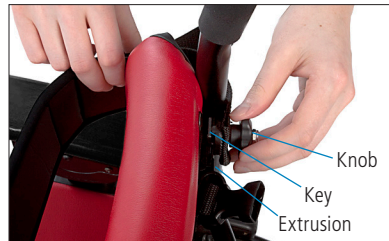

Figure 26c

Butterfly harness

⚠ WARNING To prevent falls, strangulation, head entrapment or other injuries:

- Always use seatbelt or pelvic harness when the tray, chest straps, thigh belt, mini trunk support or butterfly harness are in use.
- Ensure correct adjustment and positioning of the butterfly harness at each use.
- Always use lateral supports in conjunction with the butterfly harness if necessary to ensure clients do not slump sideways.

The butterfly harness provides anterior support while allowing maximum freedom of movement.

Figures 27a and 27b: With back of L-shape towards front of seat, attach butterfly harness by inserting L-shaped metal clip (A) at the ends of lower harness straps into slots (B) on both sides of seat. Use pen to insert clips, as shown on page 10. Press clips firmly into slot making sure clips hold when pulled. Then clip the buckles (E) to the sockets (F) on top of the backrest.

The butterfly harness can be clipped into either set of small slots at sides of chair seat. Use other set for seatbelt or pelvic harness.

Figure 27a: To remove the butterfly harness, use a pen to press the small white button (C) and pull the harness up to disengage the clip. Repeat on the other side of the seat.

Figures 27a and 27b: To completely free the butterfly harness, unclip all four buckles (D and E). Transfer the client into the Activity Chair, then place the harness pad on the user's chest. Secure all four buckles and adjust the straps as necessary.



Figure 27a



Figure 27b



Slim cut butterfly harness

The slim cut butterfly harness is slim across the chest, making it more comfortable for female clients. It performs the same positioning function as the regular butterfly harness.

To attach slim cut butterfly harness follow the regular butterfly harness instructions.

Thigh belt

⚠ WARNING To prevent falls, strangulation, head entrapment or other injuries, always use seatbelt or pelvic harness when the tray, chest straps, thigh belt, mini trunk support or butterfly harness are in use.

A thigh belt can provide additional support and security for user's thighs and helps adduct user's knees.

Figure 28a: To attach the thigh belt, unsnap and flip the seat cushion out of the way. With the thigh belt buckle side down, squeeze the belt webbing together, push it through the H-slot (A) as shown, then pull up so that the metal slide (B) fits snugly into the recessed slot. Repeat on the other side.

To remove the thigh belt, unsnap and flip the seat cushion out of the way. Pinch the belt webbing edges into the cross-bar of the H-slot (A). Push down on the strap to loosen the metal slide (B) from the recess. Pull up on the slide to free the strap. Repeat on the other side.

Figure 28b: To adjust the thigh belt, pull adjuster straps (C) threaded through either side of the center buckle (D).

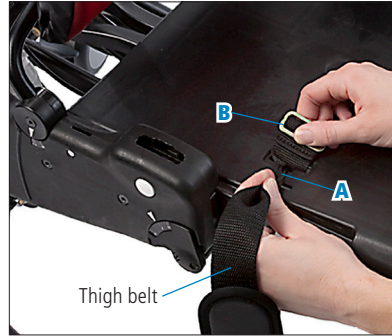

Figure 28a

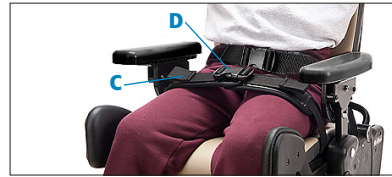

Figure 28b

Pelvic harness

⚠️ WARNING To prevent falls, strangulation, head entrapment or other injuries, always use seatbelt or pelvic harness when the tray, chest straps, thigh belt, mini trunk support or butterfly harness are in use.

The pelvic harness may be used in place of a seatbelt as the primary means of securing a user in the chair. This alternative to the more typical seatbelt gives a stable base for developing sitting postural control. The pelvic harness firmly positions the user's pelvis by securing hips and upper thighs without placing pressure on the abdomen.

Figure 29a: To attach the pelvic harness, place it on the seat with the wide ends towards the back of the seat and the strap attachment points down. Insert the L-shaped metal clips (A) into the slots (B) at either side of seat. Press clip firmly into the slot with the back of the L-shape towards the front of the seat, making sure it audibly locks into place and holds when pulled.

Figures 29b and 29c: Lay the harness pad flat on the seat as shown. Seat the client in the chair. Pull each end of the pad up between the legs and over the near leg (e.g., left pad end over the left leg). Secure the buckles (C). Tighten the straps as necessary.

To remove the pelvic harness, use a pen to press the small white button just below the clip slot on the side of the seat and pull the harness up to disengage clip. Repeat on other side of seat.

The pelvic harness can be clipped into either set of small slots at sides of the chair. Be sure to consider seat depth required for user and assess that the slot selected for attachment will allow appropriate use of pelvic harness.



Figure 29a



Figure 29b



Figure 29c

Hip guides

Hip guides give additional lateral support to the user's hips and can be adjusted independently for best fit.

Hip guides are clipped to arm supports, either armrests (A) or forearm promps, and can be removed along with arm supports for transfers.

Figure 30a: To attach the left hip guide: Remove the left arm support. Place the left hip guide over the arm support slot with the white button (B) for lateral adjustments on the outside of the chair facing the backrest. Slide the arm support through the hip guide and into the chair slot (C). Repeat for the right hip guide.

Tip: Match the raised molded armrest outline on the hip guide with the armrest shape (see Figure 30b).

Figure 30b: To adjust width between left and right hip guides, press white button (B) and move hip guide pad in and out, making sure it audibly locks into place when desired setting is reached.

Tip: Small hip guides can be used with the mini kit.



Figure 30a



Figure 30b

Abductor

The abductor keeps the user's knees comfortably apart.

Before attaching abductor, remove leg prompts, if present.

Figure 31a: To attach the abductor, insert the abductor post into the slot centered directly beneath front of seat. Reach below the slot and press the white abductor button (A) to insert abductor post into slot.

To adjust the depth of the abductor, press the white abductor button (A) and pull the abductor to desired setting. Then release the button, making sure abductor audibly locks into place.



Figure 31a

Adductors

Adductors limit lateral movement of user's knees and provide a comfortable lateral boundary.

Figure 31b: To attach the adductors, press the adductor button (B) below the front corner of the seat and insert the metal posts into the slots (C) located at the side of the seat, with adductor pads towards the seat. Release the button and make sure the adductors snap into place.

To remove an adductor, press the white button (B) and pull the adductor out.

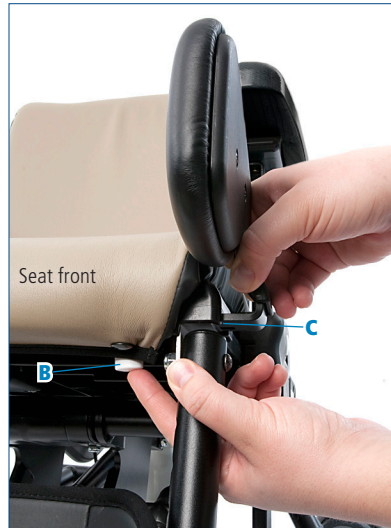

Figure 31b

Leg prompt

Leg prompt can be used in place of an abductor providing both abduction and adduction.

Before attaching leg prompt, remove abductor, if present.

Figure 32a: To attach the leg prompt, insert leg prompt post (A) into slot (B) centered beneath front of the seat. Reach below the slot and press the leg prompt button (C), to insert it.

To adjust the depth of the leg prompt to the seat, press the leg prompt button (C). Pull or push the leg prompt until the desired setting is achieved. Release the button and make sure the leg prompt audibly locks into place.

To adjust the width of the leg prompt, press the white width buttons (D) located on the plastic housing behind the leg prompt straps. Release the buttons when the desired setting is achieved, making sure the leg prompt audibly locks into place.

Figure 32b: Secure the user's legs in place with the leg prompt straps and buckles (E).

Tip: Leg prompts work best with the knee angle close to 90°.

Ankle straps

Figure 32c: Ankle straps secure the user's feet while providing a bounded range of movement.

Figure 32d: To attach the ankle straps, insert the ends of the straps into the slot at the back of the footboard. Attach the straps under the footboard with the snaps provided. Adjust straps to fit user's needs. Note that sandals cannot be used with ankle straps.

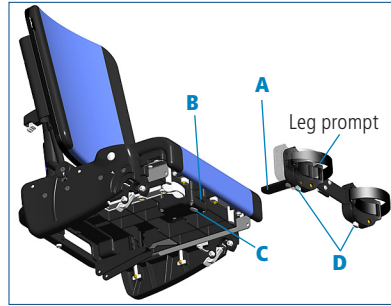

Figure 32a



Figure 32b



Figure 32c



Figure 32d

Sandals and Wedges

Sandals provide positive positioning of the user's feet and require the footboard. Adding wedges beneath the sandals allows for a custom fit of the sandal height and tilt. Sandal bases come as a left and right pair.

Figure 33a: To attach, position the sandal base (A) on the footboard above one of the pairs of slots in the footboard. Insert the long bolts from below and use the black knobs to secure the sandal base to the footboard. Begin by tightening the knobs only halfway, slide sandal base to the desired position, then tighten the knobs firmly.

Figure 33b: To attach a wedge (B), place it on the sandal base and push the bottom lever back, locking the wedge onto the base. Add wedges as needed. Place the sandal on top of the stack and lock it by pushing the corresponding white lever.

Make sure sandals and wedges are firmly locked together before use. Wedges may be used either way around when stacked.

Figure 33c: Latch each sandal (C) onto the sandal base or wedge using the white lever.

Secure the user's feet with sandal straps.

Tip: Sandals cannot be used together with ankle straps.

Tip: If you wish to use the sandals as well as the flip up feature on the footboard, adjust the sandal positions to clear the side supports.



Figure 33a



Figure 33b



Figure 33c

Lumbar and seat support kit

The lumbar and seat support kit can be custom-cut and fitted to give extra postural support.

Figure 34a: The lumbar support attaches behind the backrest pad for additional low back support. The seat support attaches beneath the seat pad to help prevent the user from sliding forward on seat.

To attach the custom lumbar and seat support, remove the seat and backrest pads, then read the installation instructions provided with the lumbar and seat support kit. Support padding may be cut or trimmed if necessary and affixed to the seat with hook and loop strips. Replace the seat and backrest pads when finished.

Backrest filler pad

Figure 34b: The backrest filler pad provides additional lower back support when the chair backrest is high, creating an open space between backrest and seat.

Figure 34c: To attach the backrest filler pad, snap it into place on the snap stud centered at the bottom rear edge of the backrest.



Figure 34a



Figure 34b

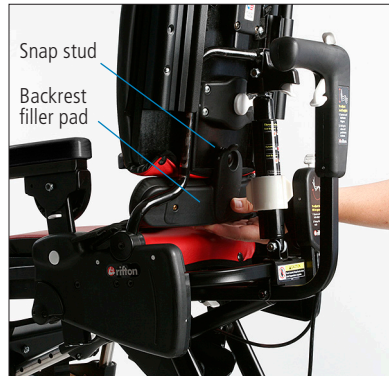

Figure 34c

Tray

⚠ WARNING To prevent falls, strangulation, head entrapment or other injuries, always use seatbelt or pelvic harness when the tray, chest straps, thigh belt, mini trunk support or butterfly harness are in use.

The tray provides a work, play and feeding surface and adjusts in height, angle and depth. A softly-rounded rim contains spills. The tray attaches to the armrests, not to the forearm prompts.

Figure 35a: To attach the tray, first set both armrests to same height and angle. Pull the black handle on the tray and slide it onto the armrests.

To adjust the tray depth, pull the black handle and slide the tray forward or back. When the desired position is reached, release the handle and make sure the tray audibly locks into place.

Adjust the tray height and angle by adjusting the armrest height and angle with the tray attached (see page 11).

Handhold

The handhold can be attached anywhere along rim of tray to provide additional support and security.

Figure 35b: To attach and adjust the handhold, loosen the large oval knob and slide the handhold along the tray until the desired position is reached, then tighten the knob securely.



Figure 35a

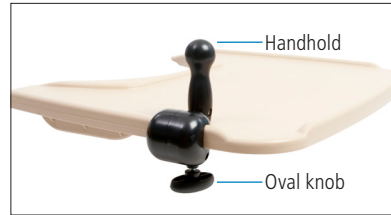

Figure 35b

Push handles

Push handles provide an ergonomic way for a caregiver to maneuver the chair and transport the user.

Figure 36a: To attach push handles (A), press the snap button (B) at the bottom of each push handle and insert it into the backrest extrusions (C) on each side of the backrest.

To adjust the push handle height, press the snap button (B) and move the handle up or down until the desired height is reached. Release the button, making sure handle audibly locks into place.



Figure 36a

Mini kit (R820 & R830 only)

⚠ WARNING

To prevent falls, strangulation, head entrapment or other injuries:

- Always use seatbelt or pelvic harness when the tray, chest straps, thigh belt, mini trunk support or butterfly harness are in use.
- Ensure correct adjustment and positioning of the mini trunk support at each use.

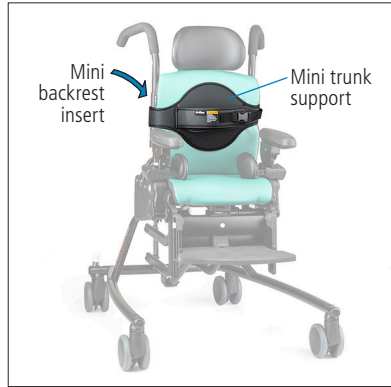

Figure 37a

Figure 37a: The mini kit makes the small Activity Chair a prime option for the smallest child, from approximately 8 months up to 2 years. Remove it as the child grows to keep using the same chair for many more years.

Figure 37b: The mini trunk support provides lateral and anterior support for the user and can be adjusted in height and width. To attach, loosen knobs (A) and insert the keys (B) into the extrusions (C) behind the backrest. Slide the knobs up and down until the trunk support is at the desired height. Tighten the knobs firmly.



Figure 37b Mini trunk support

Figure 37c: The mini backrest insert reduces the seat depth by 1" (3 cm). To install the mini backrest insert, unsnap the top edge of the backrest pad, slide the insert in and re-attach the pad.

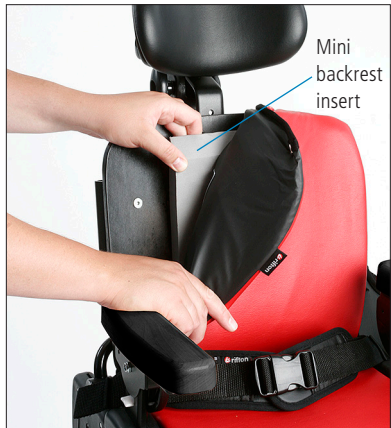

Figure 37c Mini backrest insert

Maintenance

This product is designed and tested for an expected life of 5 years when used and maintained in accordance with this manual. At all times, users must ensure that the product remains in a safe and useable condition, including regular maintenance and inspections as specified in this manual.

To prevent structural failure, which may result in serious injury or death:

- Inspect this product and components regularly for loose or missing screws, metal fatigue, cracks, broken welds, missing attachments, general instability or other signs of excessive wear.
- Immediately remove this product from use when any condition develops that might make operation unsafe.
- Do not use Rifton components or products for any purpose other than their intended use.
- Replace or repair components or products that are damaged or appear to be unstable.
- Use only Rifton authorized replacement parts. Order information for replacement parts is provided on the back of this product manual.

Cleaning

After each use, clean with disinfectant wipes or a solution of up to 10% bleach. Do not use excessive amounts of water.

The upholstery should be cleaned in the same manner. You may also use a commercial cleaning agent suitable for imitation leather.

The harnesses and padded straps should also be wiped down. Do not machine wash.

The sandal straps with hook and loop closures may be laundered. Engage the closures before washing. Do not iron.

Warranty Statement

If a Rifton product breaks or fails in service during the first year, we will replace it free of charge.

Materials

- Steel hardware items (nuts, bolts, screws, etc) are typically nickel plated or stainless steel.
- Upholstery items (pads, support blocks, padded prompts, etc) are typically polyurethane foam with a fire-retardant cover made from expanded polyurethane.
- Frames are typically steel or aluminum tubing, welded together, and coated with a baked-on paint finish. Some frame components may also be stainless steel.
- Straps are typically made of polypropylene or nylon webbing.
- Wooden components are typically birch plywood, solid maple or laminated hardwood veneers, finished with a clear polyurethane lacquer.
- Plastic components are typically injection molded from a variety of industrial resins.

All components are lead free and not made with natural rubber latex.

User modifications

WARNING

To prevent serious injury or death, do not modify or alter Rifton products or components, or use Rifton products or components in conjunction with products from other manufacturers. Rifton does not accept responsibility for any modifications or alterations made to our components or products after they leave our premises. Customers modifying or altering our components or products, or using them in conjunction with products from other manufacturers, do so at their own risk.

Rifton Contact Information



Email
sales@rifton.com



Phone
800.571.8198
9–5 EST



Mail
Rifton Equipment
PO Box 260
Rifton NY 12471–0260



Fax
800.865.4674



Online
www.rifton.com

To order replacement parts

1. **Locate the serial number** of the product on the small white label.
2. Have this number available when you call **800.571.8198** for your customer service representative.

Use only replacement parts supplied by Rifton Equipment.

We are glad to supply replacement parts. Although Rifton makes every effort to supply correct parts and instructions for repairing or refurbishing your equipment, you are responsible to make sure that the repairs or modifications are correctly and safely completed.



Find in-service videos, letters of medical necessity and informative articles at:
www.rifton.com/activitychair



Searching for a quick answer?

Look in our **Quick Reference Guide** located in a pocket behind the back cushion of your Rifton Activity Chair.